



**VIPPLE**  
ENTERPRISES

# **SURGICAL CATALOGUE**

Probes | Cotton Applicator

Sonden | Watteträger

Sondes | Applicateur de coton

Sondas | Porta-algodón

Sonde | Portacotone

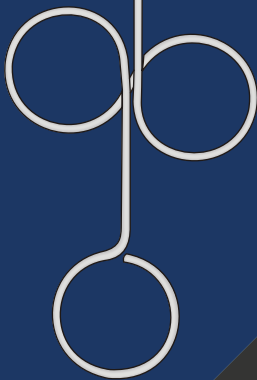

Hohlsonde

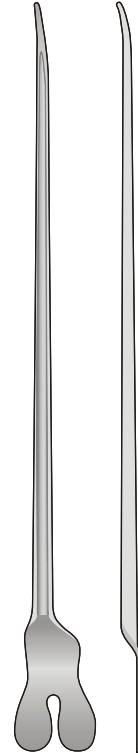
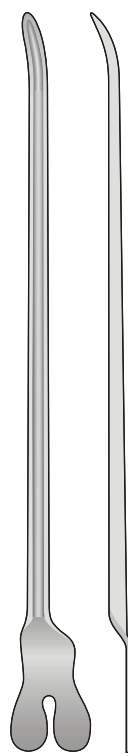
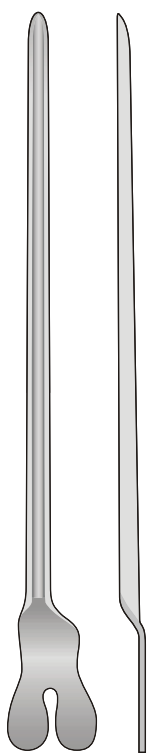
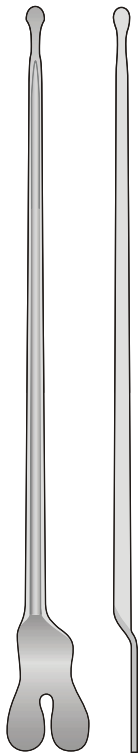

**TM-PF-54** 145mm  
**TM-PF-55** 160mm  
**TM-PF-19** 180mm  
**TM-PF-56** 200mm

**TM-PF-53** 130 mm  
**TM-PF-57** 145 mm  
**VE-PF-58** 160 mm  
**TM-PF-59** 180 mm  
**TM-PF-18** 200 mm

**DOYEN**  
**TM-PF-24**  
 145 mm

**NELATON**  
**TM-PF-17**  
 160 mm

Sonde per fistole - Fistula probes - Fistelsonden - Sondes pour fistules - Sondas para fistulas

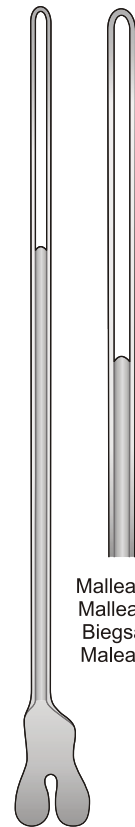
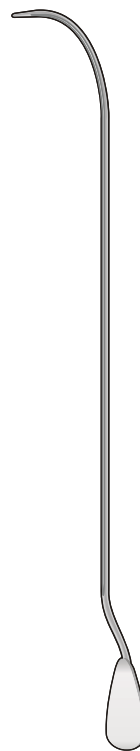
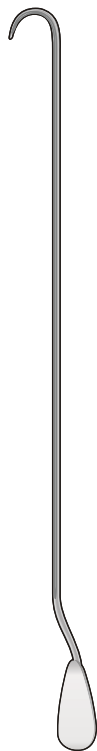
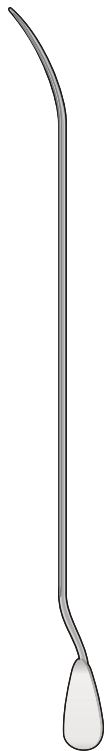

1/1  
 Malleabile  
 Malleable  
 Biegsam  
 Maleable

**LOCHART**  
**TM-PF-80**  
 170 mm

**LOCHART**  
**TM-PF-81**  
 170 mm

**LOCHART**  
**TM-PF-82**  
 170 mm

**LOCHART**  
**TM-PF-83**  
 170 mm

**LOCHART**  
**TM-PF-85**  
 190 mm

Ø 1 mm



Ø 1,5 mm



Ø 2 mm



Ø 2 mm



Ø 1,5 mm

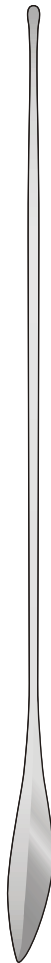

Ø 1,0 mm



**VE-PF-20** 145 mm  
**VE-PF-21** 160 mm

**VE-PF-32** 130 mm  
**VE-PF-22** 145 mm  
**VE-PF-25** 160 mm  
**VE-PF-26** 200 mm

**VE-PF-27** 145 mm  
**VE-PF-23** 160 mm  
**VE-PF-28** 200 mm  
**VE-PF-44** 250 mm

**VE-PF-36** 130 mm  
**VE-PF-15** 145 mm  
**VE-PF-29** 160 mm  
**VE-PF-38** 200 mm

**VE-PF-7** 145 mm

STACKE  
**VE-PF-14** 110 mm

**VE-PF-30**  
**VE-PF-31**  
**VE-PF-33**

BOWMAN  
 00/0 **VE-PF-34** 5/6  
 1/2 **VE-PF-35** 7/8  
 3/4 **VE-PF-37** 6/7

Ø 1,2 mm

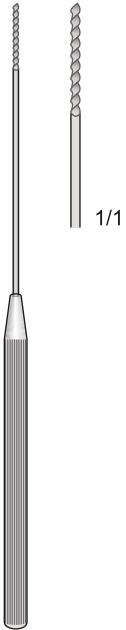

UNIVERSAL  
**VE-PF-48** 120 mm  
**VE-PF-40** 140 mm  
**VE-PF-50** 160 mm

Ø 1,8 mm

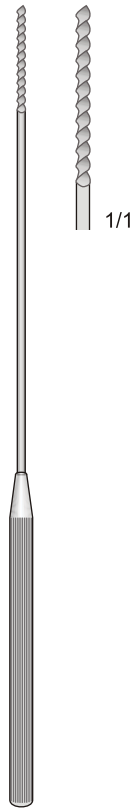

UNIVERSAL  
**VE-PF-62** 120 mm  
**VE-PF-63** 140 mm  
**VE-PF-64** 160 mm  
**VE-PF-41** 180 mm

Ø 1,2 mm

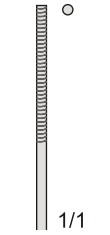

**VE-PF-43** 140 mm  
**VE-PF-51** 160 mm

Rotondo  
 Round  
 Rund  
 Rondes  
 Redondas

Ø 1,5 mm

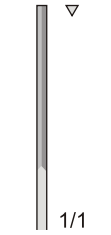

**VE-PF-46** 140 mm  
**VE-PF-52** 160 mm

Triangolare  
 Triangular  
 Dreikant  
 Triangulaires  
 Triangulares

Ø 1,5 mm

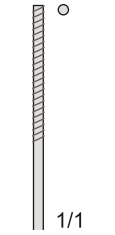

**VE-PF-49** 180 mm

Rotondo  
 Round  
 Rund  
 Rondes  
 Redondas

Ø 0,9 mm

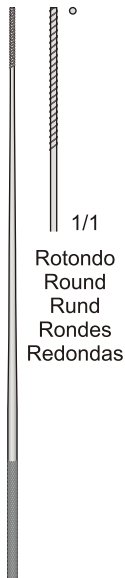

FARRELL  
**VE-PF-10** 120 mm

Rotondo  
 Round  
 Rund  
 Rondes  
 Redondas

Ø 0,9 mm

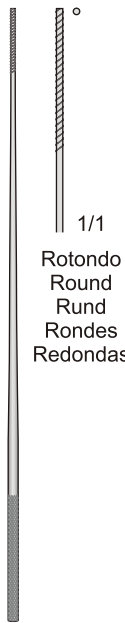

FARRELL  
**VE-PF-13** 140 mm  
**VE-PF-66** 160 mm  
**VE-PF-67** 180 mm

Rotondo  
 Round  
 Rund  
 Rondes  
 Redondas

Ø 0,9 mm

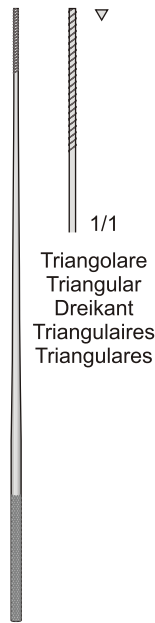

FARRELL  
**VE-PF-68** 140 mm  
**VE-PF-69** 160 mm

Triangolare  
 Triangular  
 Dreikant  
 Triangulaires  
 Triangulares

Ø 1,2 mm

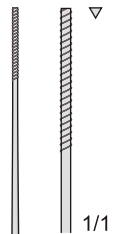

FARRELL  
**VE-PF-39** 180 mm

Triangolare  
 Triangular  
 Dreikant  
 Triangulaires  
 Triangulares

Ø 1,3 mm

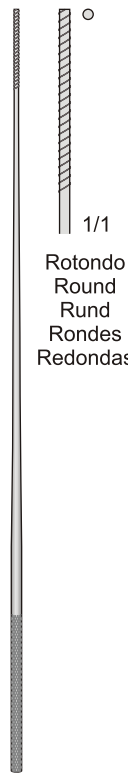

FARRELL  
**VE-PF-42** 230 mm

Rotondo  
 Round  
 Rund  
 Rondes  
 Redondas

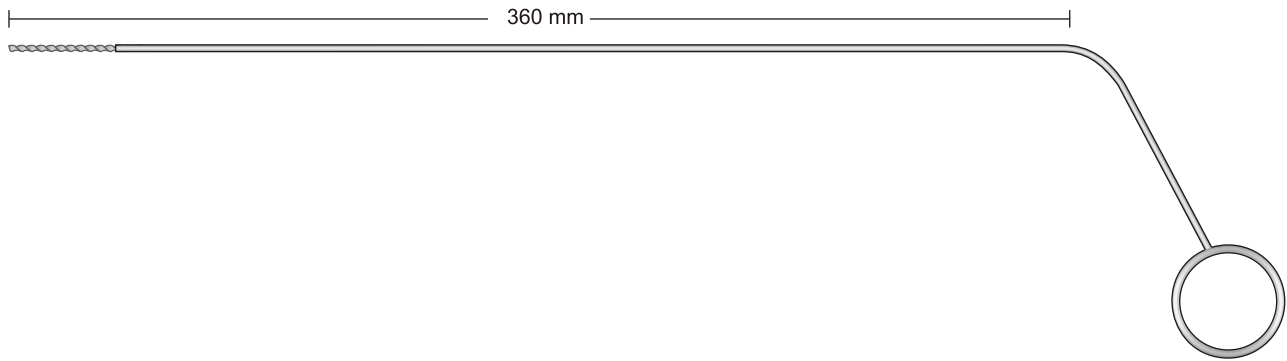

**VE-PF-88**  
400 mm

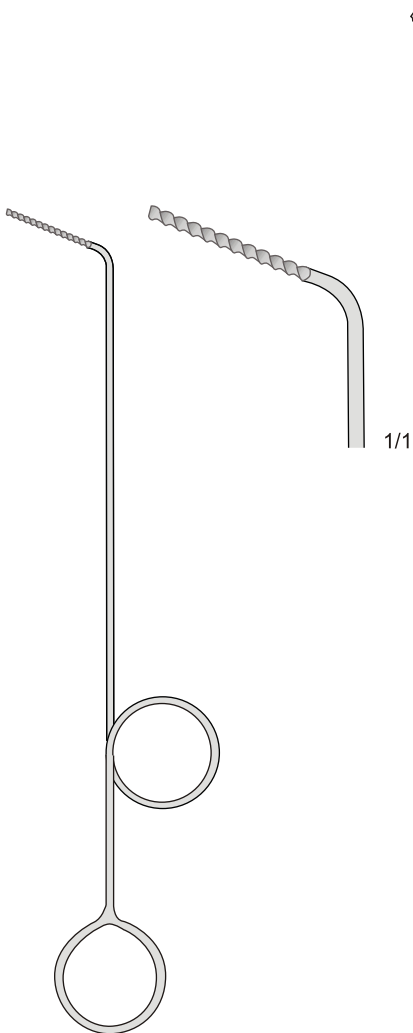

HARTMANN  
**VE-PF-73**-Ø 2,3 mm  
220 mm

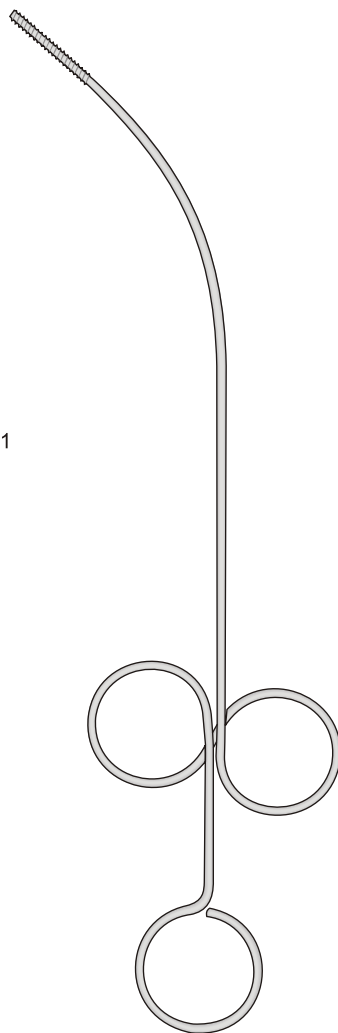

FEIN  
**VE-PF-65**  
250 mm



HEILDEBERG  
**VE-PF-60**  
180 mm

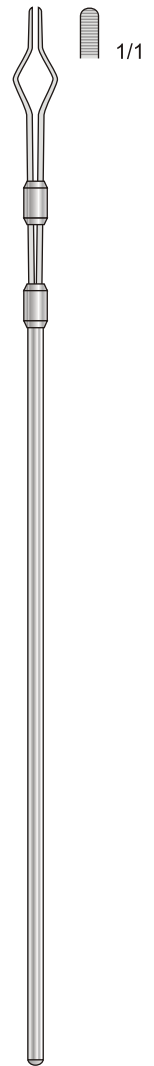

HEILDEBERG  
**VE-PF-61**  
170 mm

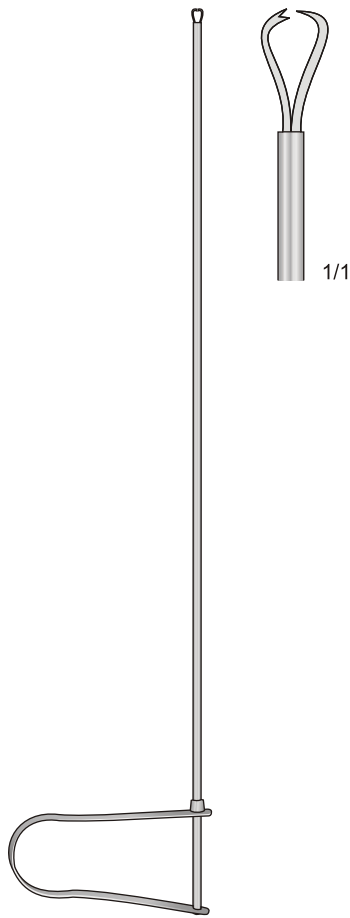

**VE-PF-70**  
300 mm

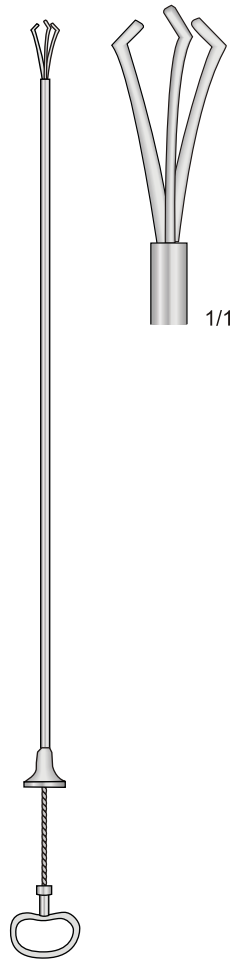

**FRANKFELDT**  
**VE-PF-71**  
360 mm

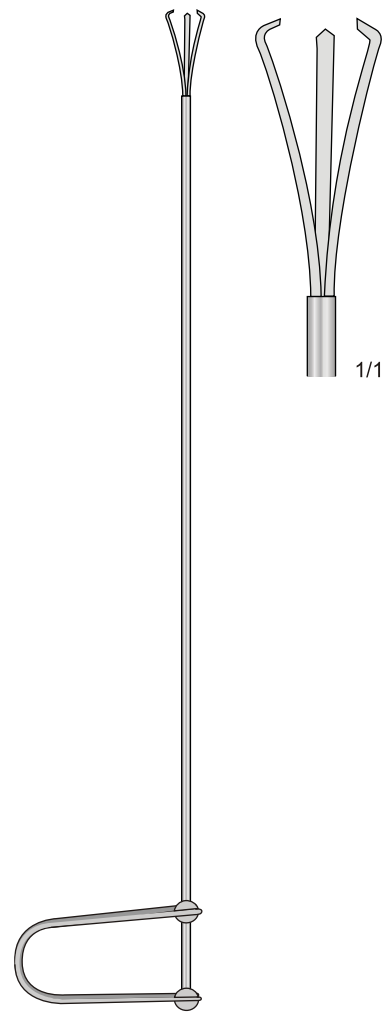

**EDER**  
**VE-PF-72**  
380 mm



**VIPPLE**  
**ENTERPRISES**

 Daska Road,  
Sialkot 51310- Pakistan.

 +92 305 862 3893

 info@vippleent.com  
vippleent@gmail.com

 www.vippleent.com