

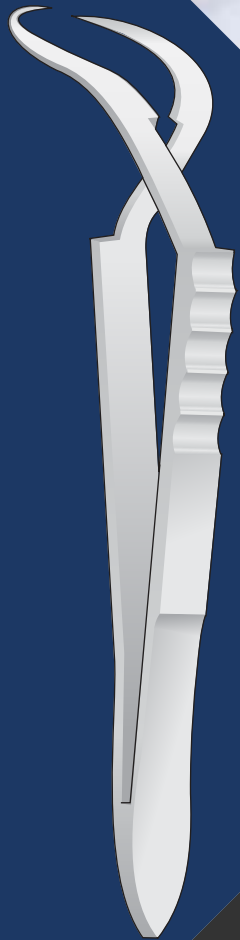

VIPPLE
ENTERPRISES



DENTAL CATALOGUE

Hemostatic Forceps | Towel Clamps
Arterienklemmen | Tuchklemmen
Pincés hémostatiques | Pincés à champs
Pinzas hemostáticas | Pinzas de campo
Pinzette emostatiche | Fissateli

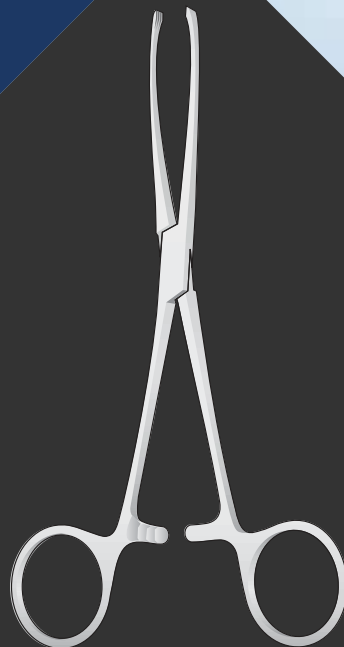

Tuchklemmen
Towel Clamps
Fissateli
Pinzas de campo
Pincas fixe-compresses

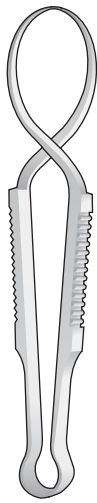

SCHAEDDEL
VE-BF-38
85 mm

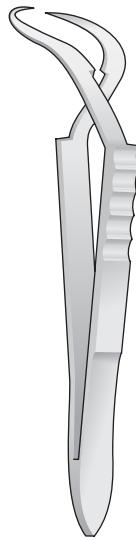

JONES
VE-BF-48
90 mm

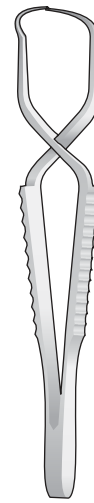

FAURE
VE-BF-40
85 mm

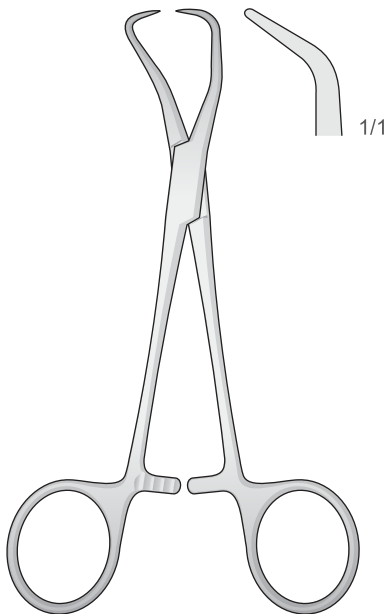

BACKHAUS
VE-BF-42/VE-BF-46

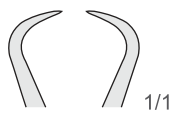

VE-BF-42
90 mm

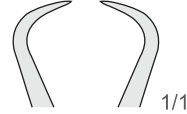

VE-BF-41
100 mm

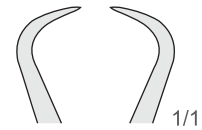

VE-BF-44
110 mm

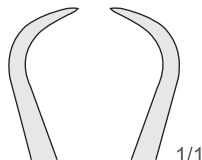

VE-BF-46
130 mm

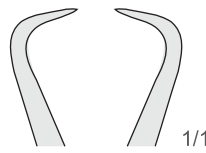

VE-BF-43
135 mm

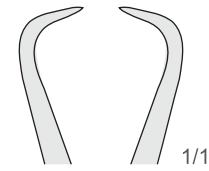

VE-BF-45
140 mm

Tuchklemmen
Towel Clamps
Fissateli
Pinzas de campo
Pincas fixe-compresses

Für Papiertücher
For paper cloths
Per teli di carta
Para paños
Pour papier

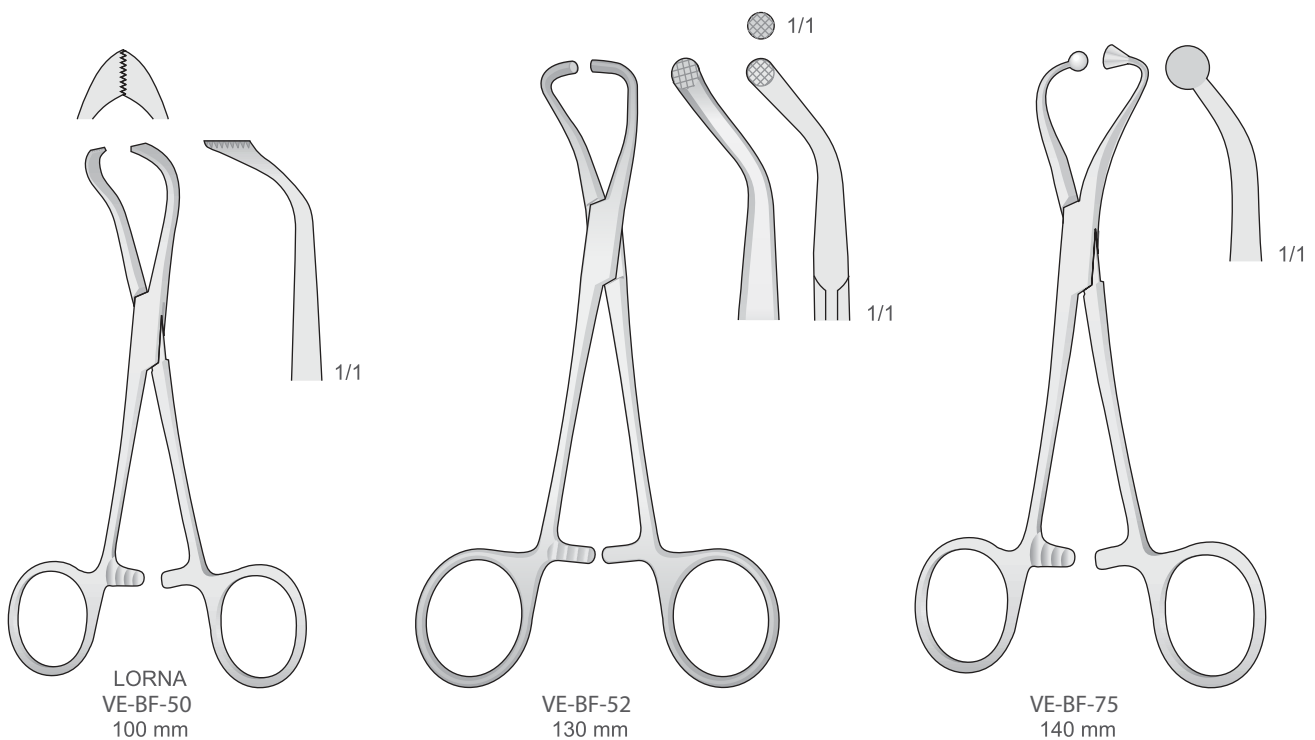

Schwamm und Tamponzangen
Sponge and Dressing Forceps
Pinze per tamponi e sponge
Pinzas para esponja y tampones
Pinces pour éponges et à pansement

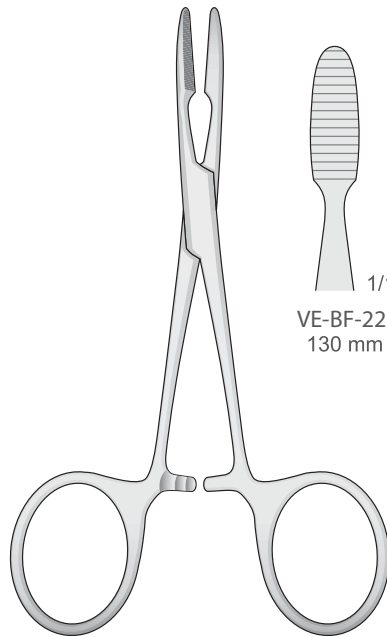

PEAN-MURPHY
VE-BF-22/VE-BF-24

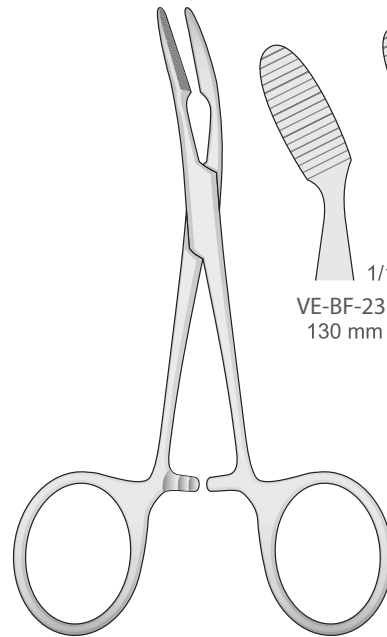
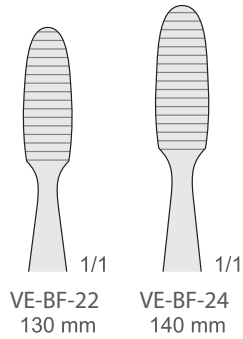

PEAN-MURPHY
VE-BF-23/VE-BF-25

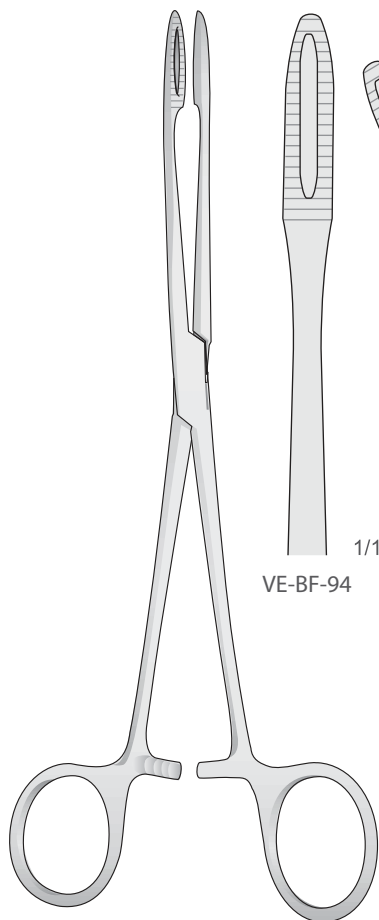
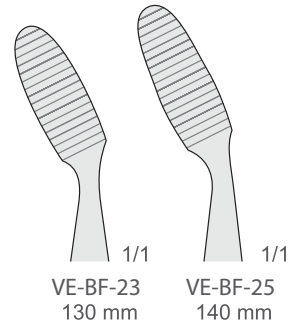

GROSS
VE-BF-94/VE-BF-95
200 mm

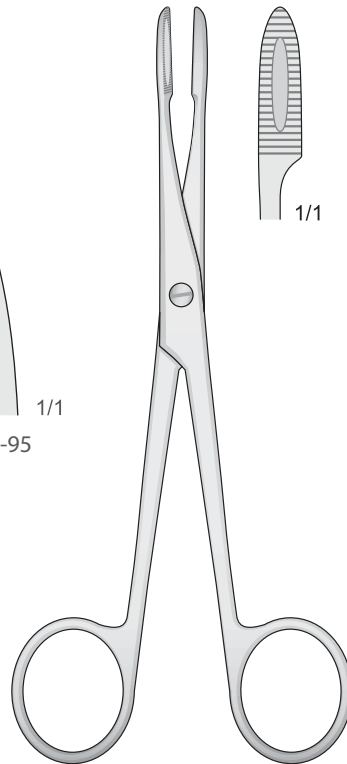
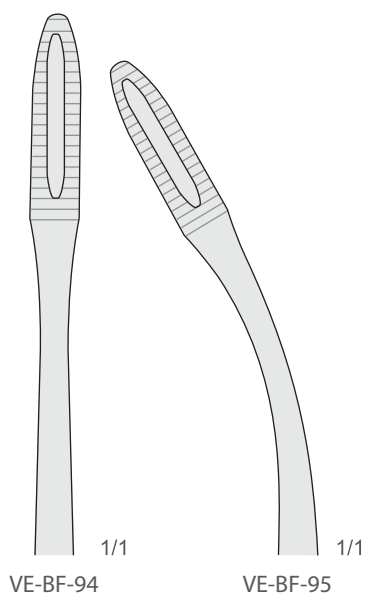

GROSS
VE-BF-10 130 mm
VE-BF-12 160 mm

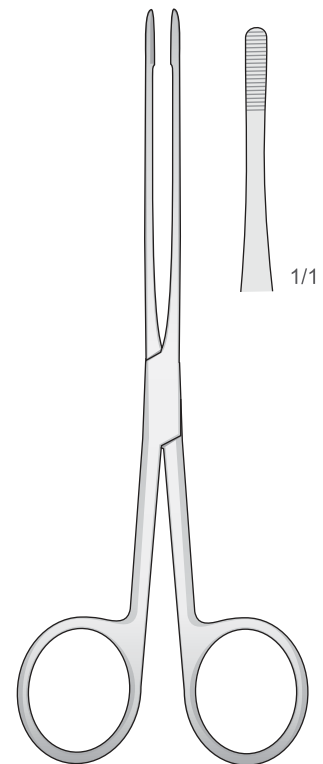
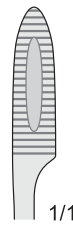

LISTER
VE-BF-20
150 mm

Sinus klemmen
Sinus forceps
Pinze Sinus
Pinzas para seno
Pinces à Sinus

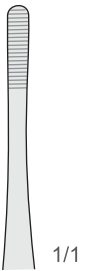

Arterienklemmen
Hemostatic Forceps
Pinze emostatiche
Pinzas hemostáticas
Pincas hémostatiques

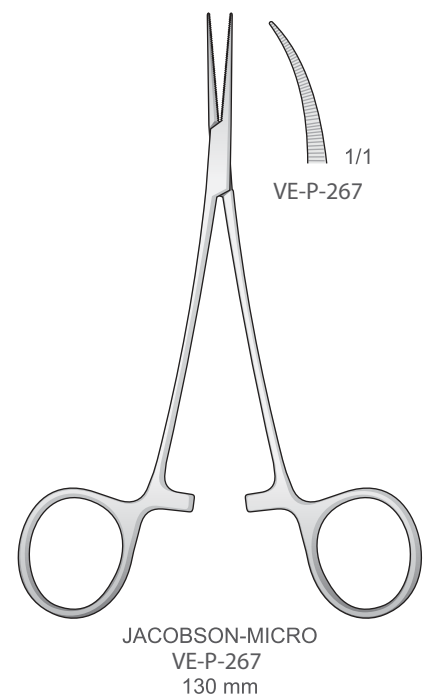
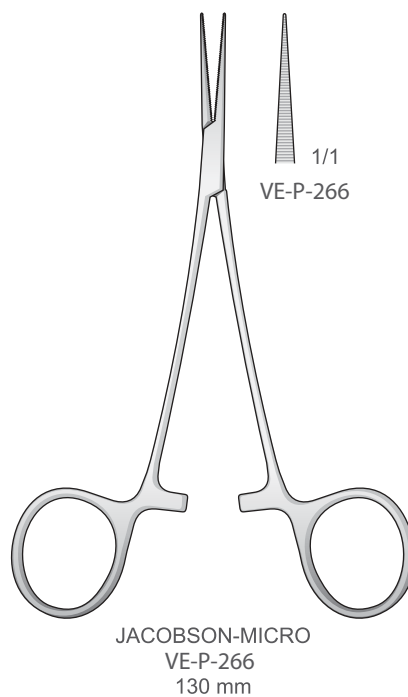
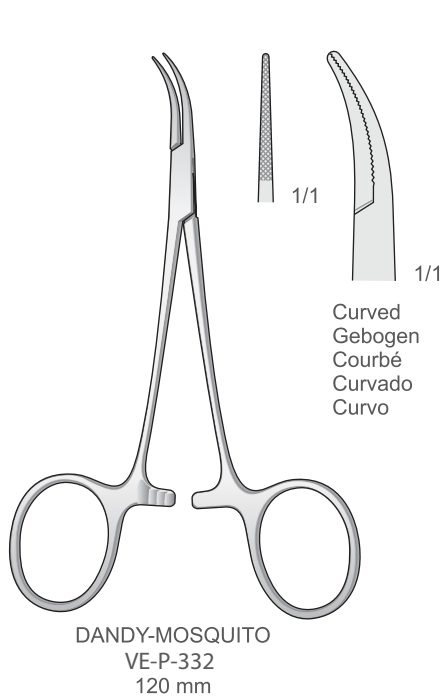
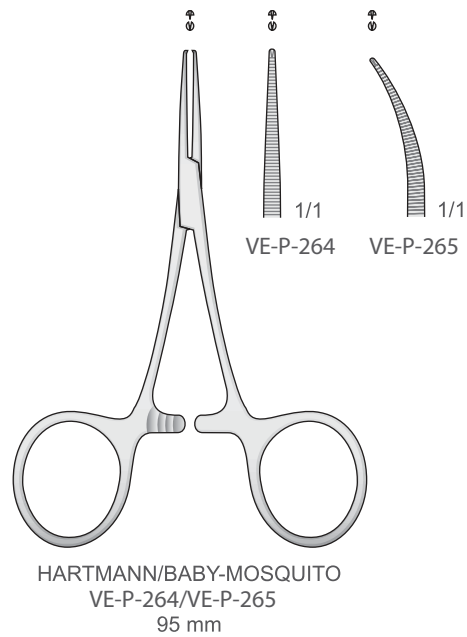
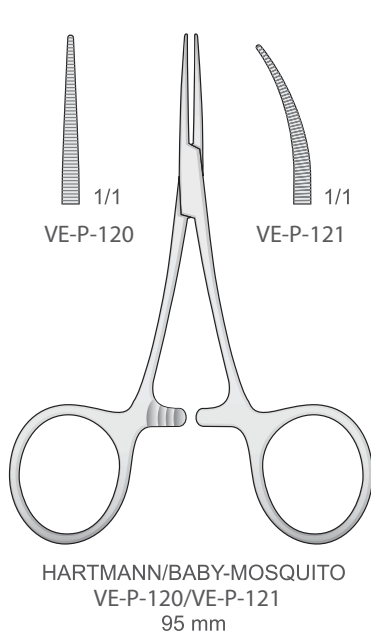

Arterienklemmen
Hemostatic Forceps
Pinze emostatiche
Pinzas hemostáticas
Pincés hémostatiques

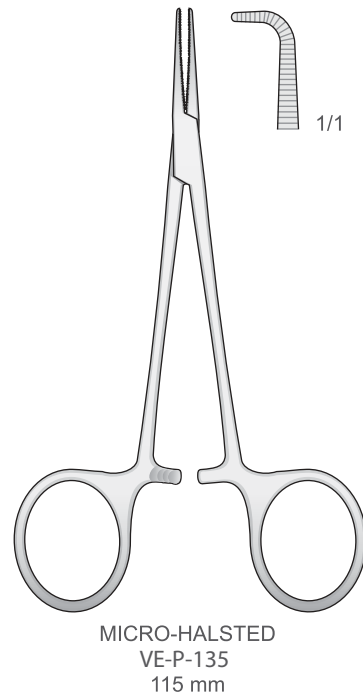
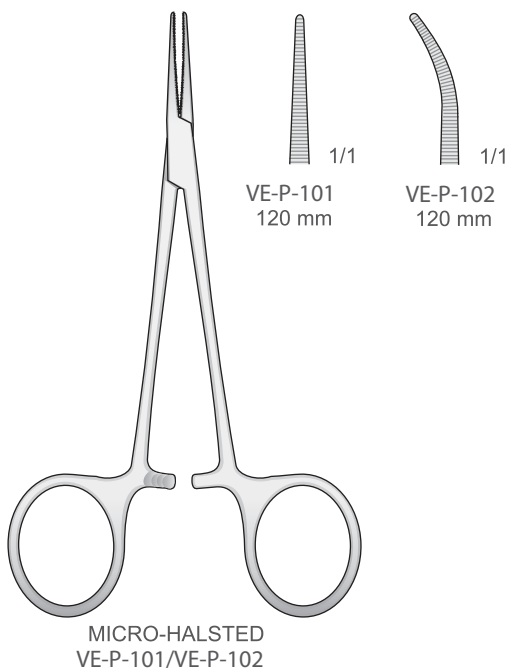
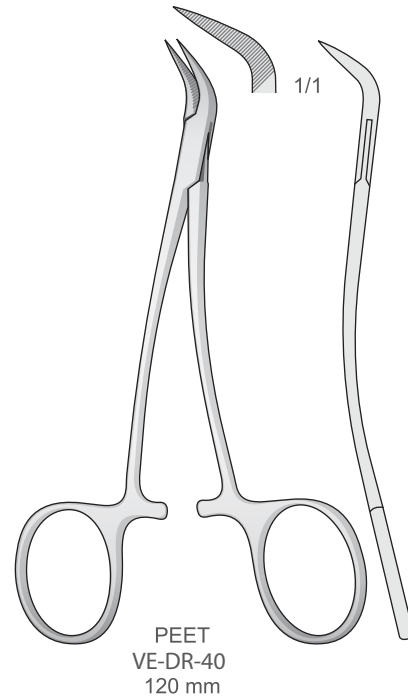
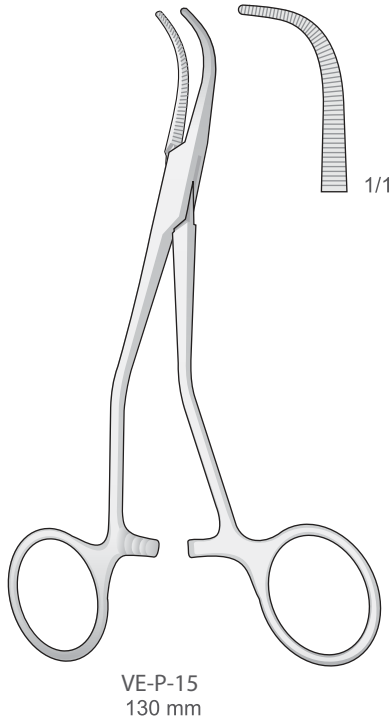

Arterienklemmen
Hemostatic Forceps
Pinze emostatiche
Pinzas hemostáticas
Pincas hémostatiques

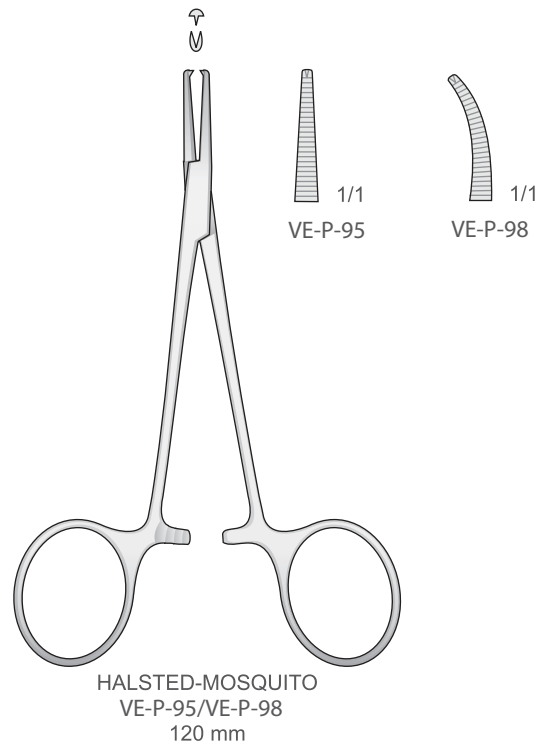
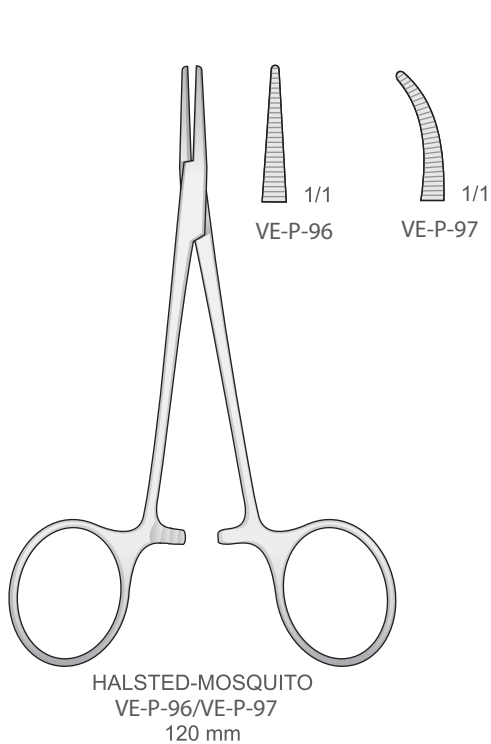
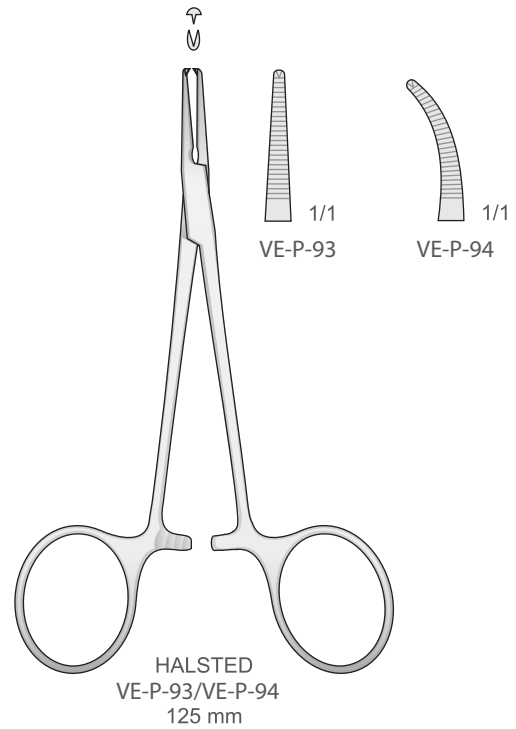
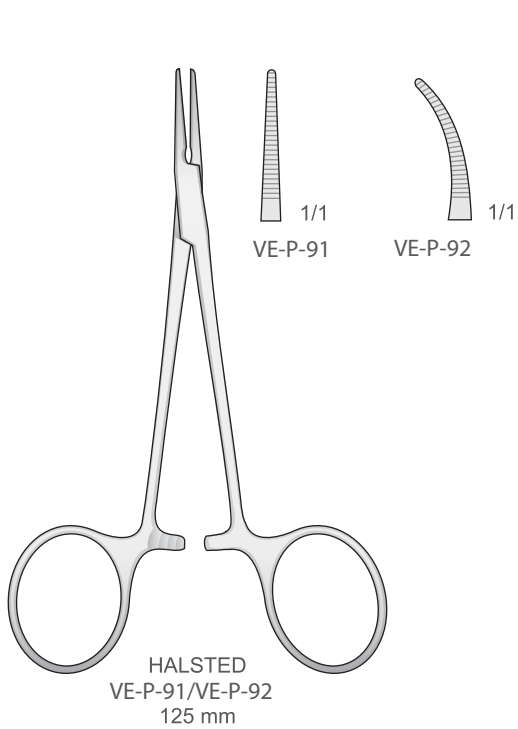

Arterienklemmen
Hemostatic Forceps
Pinze emostatiche
Pinzas hemostáticas
Pincas hémostatiques

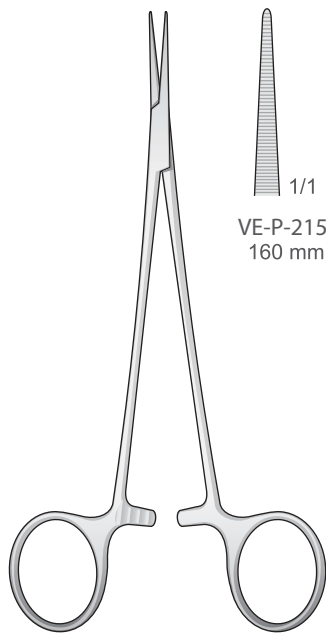

VE-P-215/VE-P-217
160 mm

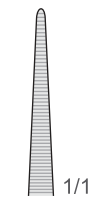

VE-P-215
160 mm

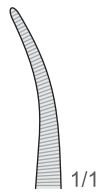

VE-P-216
160 mm

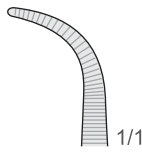

VE-P-217
160 mm

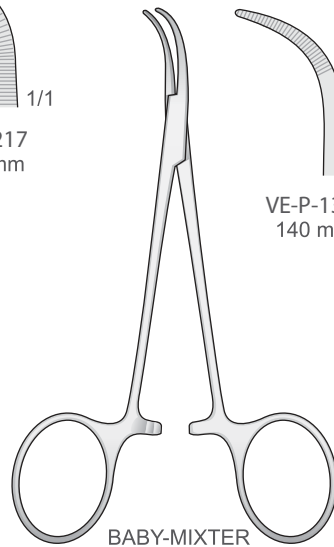

BABY-MIXTER
VE-P-136/VE-P-137

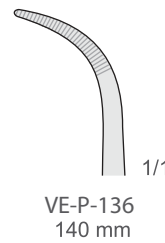

VE-P-136
140 mm

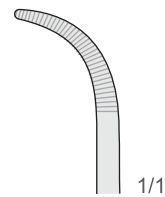

VE-P-137
180 mm

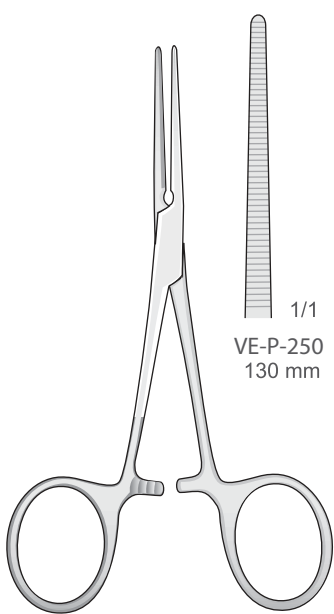

PEAN
VE-P-250/VE-P-253

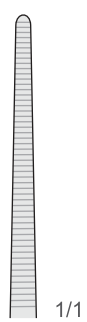

VE-P-250
130 mm

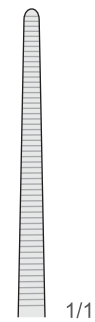

VE-P-252
140 mm

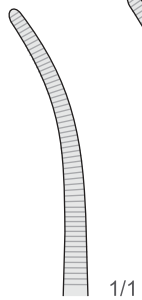

VE-P-251
130 mm

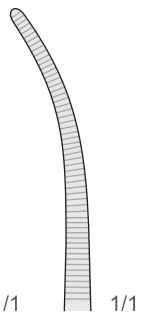

VE-P-253
140 mm

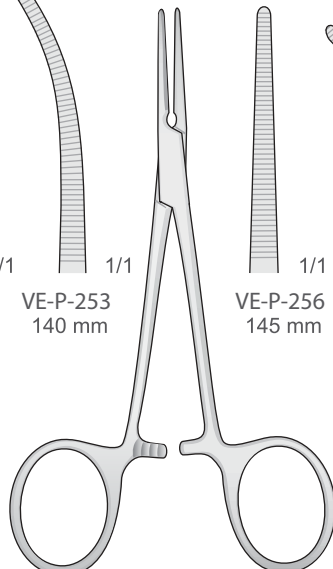

PEAN
VE-P-256/VE-P-257

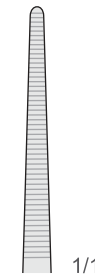

VE-P-256
145 mm

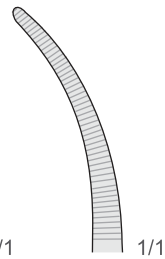

VE-P-257
145 mm

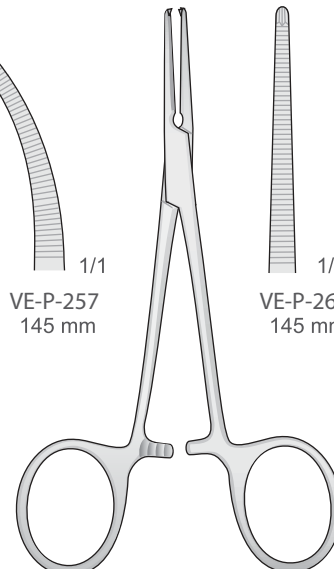

KOCHER
VE-P-260/VE-P-261

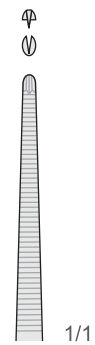

VE-P-260
145 mm

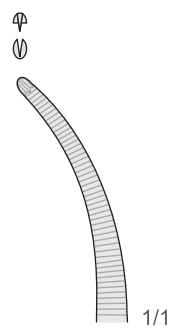

VE-P-261
145 mm

Arterienklemmen
Hemostatic Forceps
Pinze emostatiche
Pinzas hemostáticas
Pinces hémostatiques

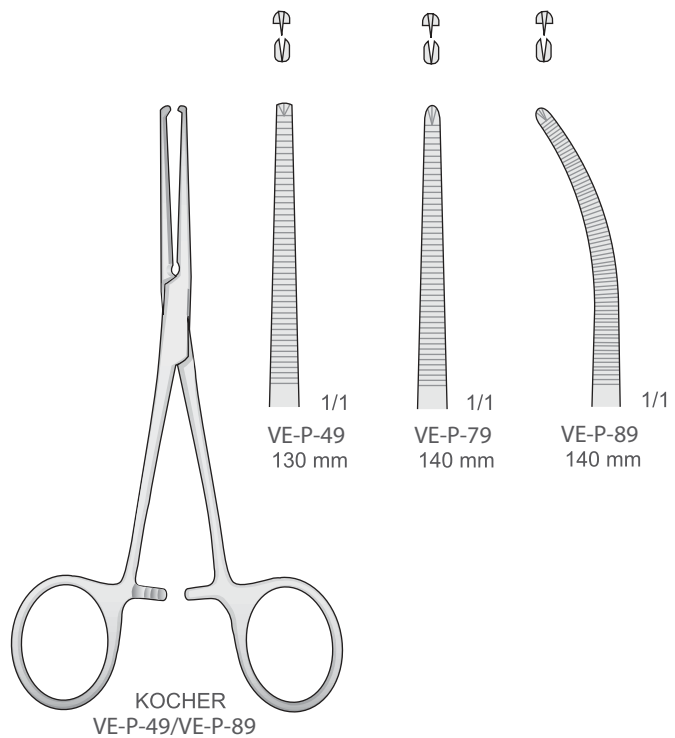
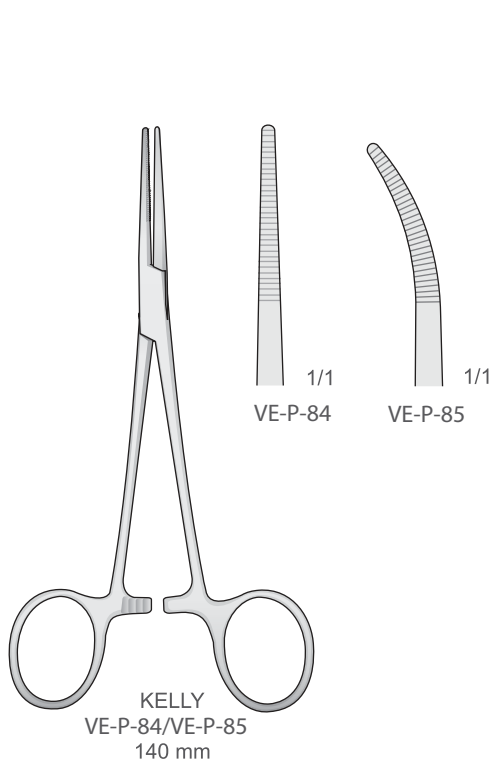
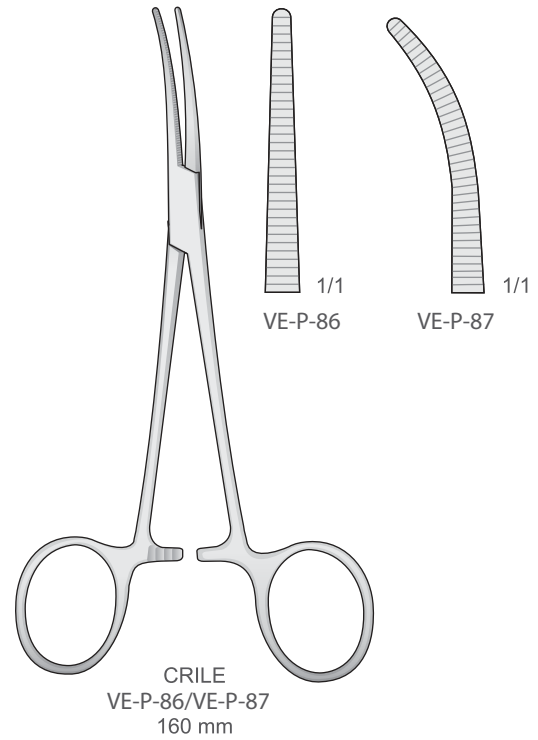
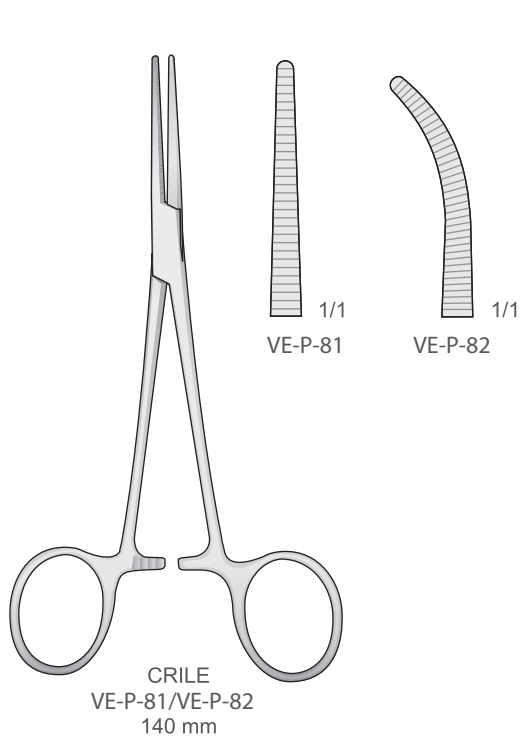

Arterienklemmen
 Hemostatic Forceps
 Pinze emostatiche
 Pinzas hemostáticas
 Pincas hémostatiques

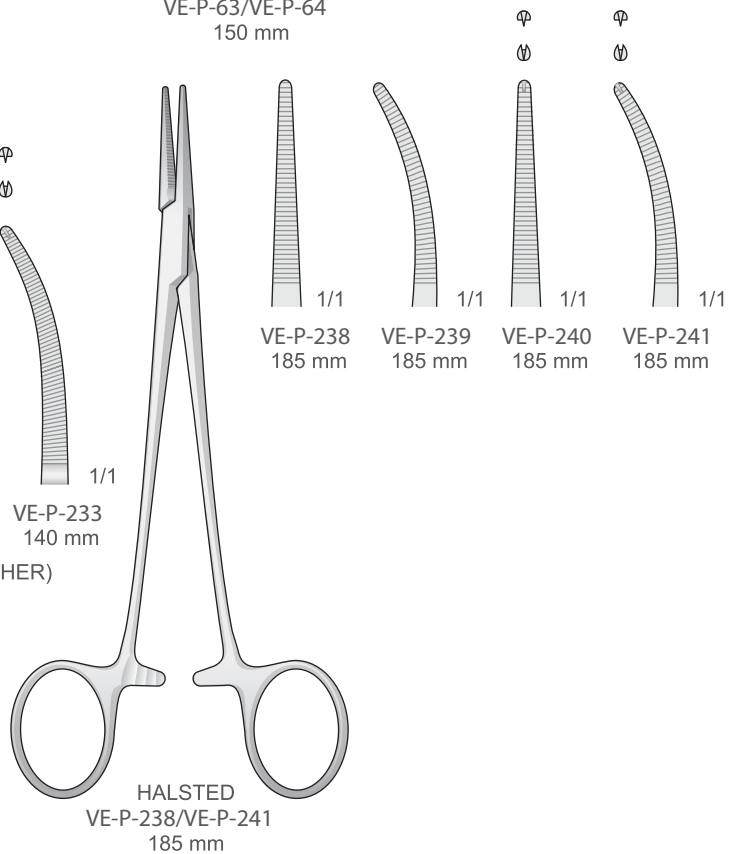
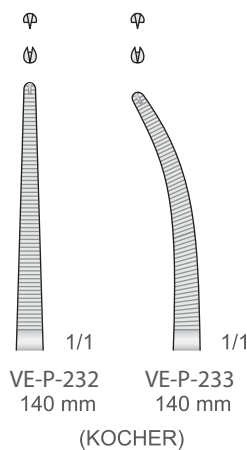
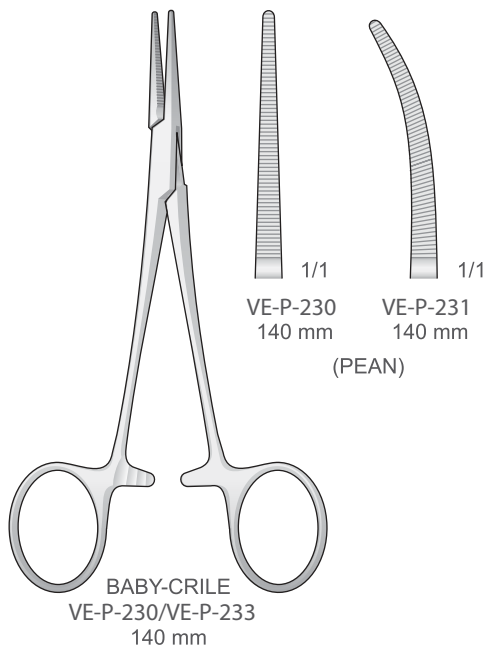
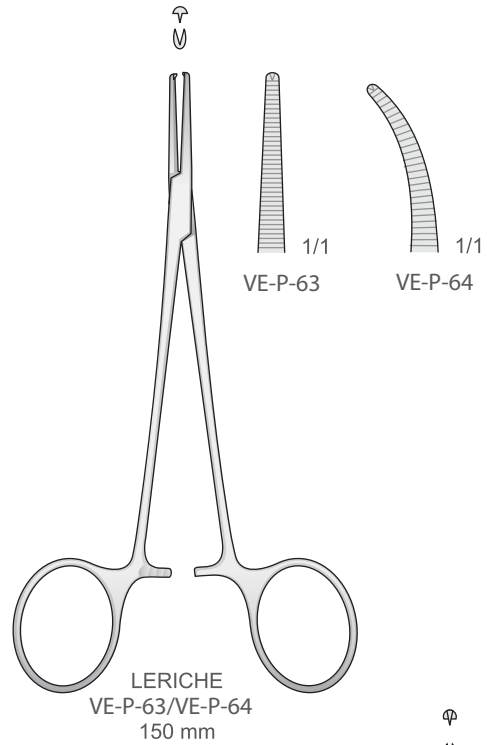
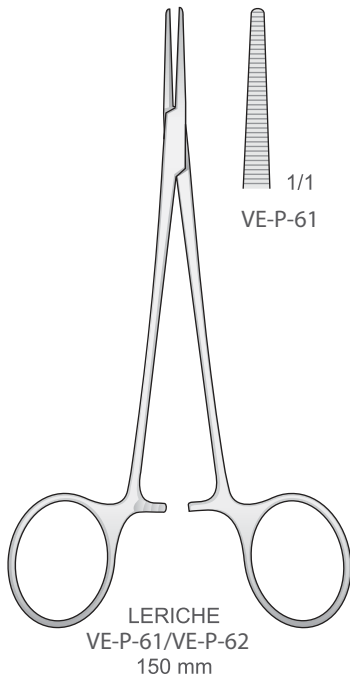

Gewebefasszangen
Tissue Grasping Forceps
Pinze per tessuti
Pinzas para tejidos
Pincas pour tissus

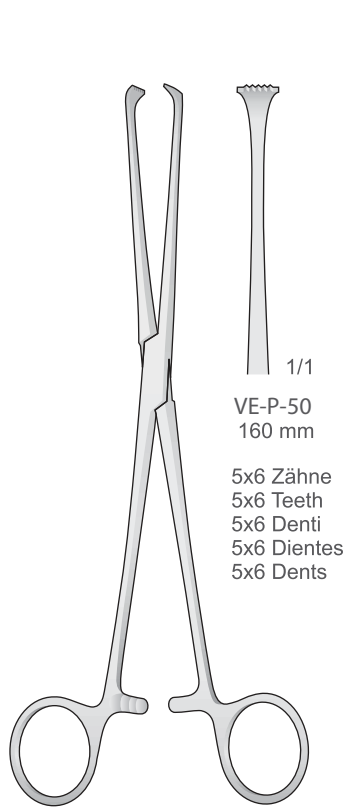

ALLIS
VE-P-50/VE-P-52

VE-P-50
160 mm
5x6 Zähne
5x6 Teeth
5x6 Denti
5x6 Dientes
5x6 Dents

ATRAUMA

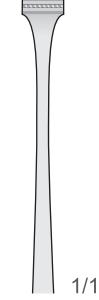

VE-P-52
160 mm

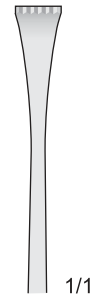

VE-P-115
200 mm
5x6 Zähne
5x6 Teeth
5x6 Denti
5x6 Dientes
5x6 Dents

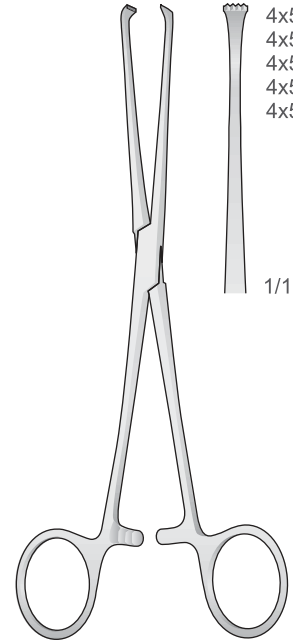

BABY-ALLIS
VE-P-100
130 mm

4x5 Zähne
4x5 Teeth
4x5 Denti
4x5 Dientes
4x5 Dents

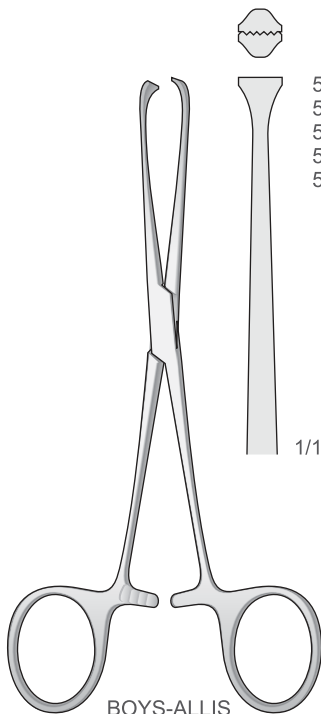

BOYS-ALLIS
VE-P-129
150 mm

5x6 Zähne
5x6 Teeth
5x6 Denti
5x6 Dientes
5x6 Dents

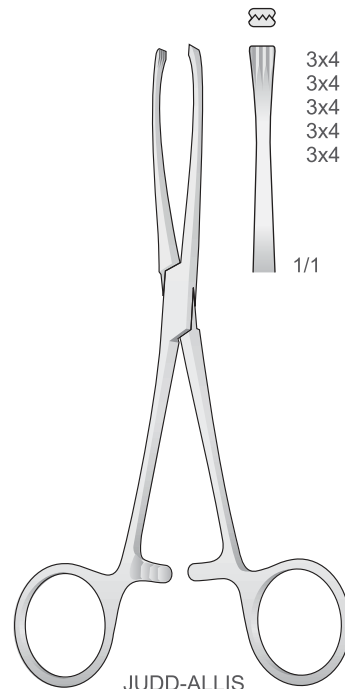



JUDD-ALLIS
VE-P-324
155 mm

3x4 Zähne
3x4 Teeth
3x4 Denti
3x4 Dientes
3x4 Dents



VIPPLE
ENTERPRISES

 Daska Road,
Sialkot 51310- Pakistan.

 +92 305 862 3893

 info@vippleent.com
vippleent@gmail.com

 www.vippleent.com